

Q45AD9CV4Q

Photoelectric Sensor – Convergent Mode Sensor

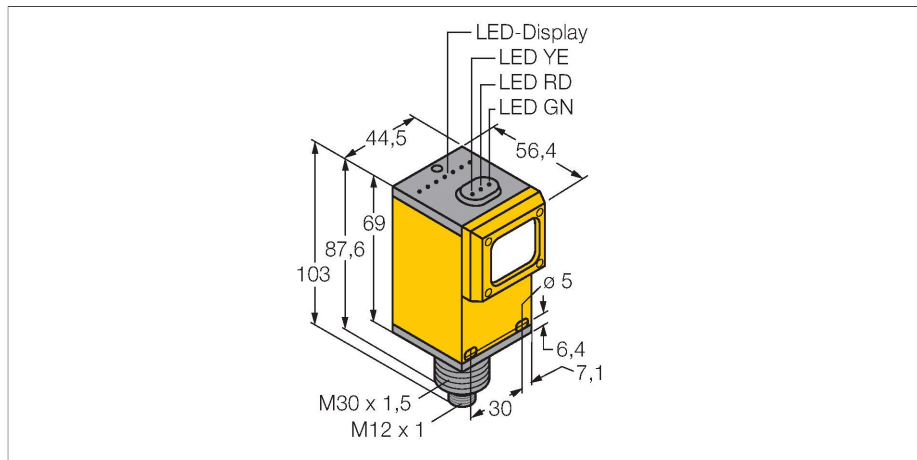

Features

- Male M12 × 1
- Protection class IP67
- Sensitivity adjusted via potentiometer
- Operating voltage: 5...15 VDC
- NAMUR output: dark ≤ 1.2 mA ; light ≥ 2.1 mA
- Acc. to EN 60947-5-6 (NAMUR)
- ATEX category II 1 G, Ex zone 0

Wiring diagram

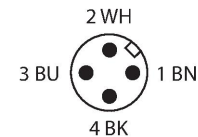
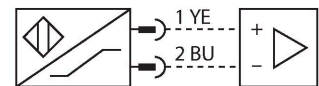

Technical data

Type	Q45AD9CV4Q
ID	3037634
Optical data	
Function	Proximity switch
Operating mode	Convergent
Light type	Red
Wavelength	680 nm
Focal distance	100 mm
Range	100 mm
Electrical data	
Operating voltage	5...15 VDC
Voltage	Nom. 8.2 VDC
Current consumption non-actuated	≤ 1 mA
Actuated current consumption	≥ 2.1 mA
No-load current	≤ 2.1 mA
Output function	Light operation, NAMUR
Switching frequency	≤ 100 Hz
Readiness delay	≤ 0 ms
Response time typical	< 5 ms
Setting option	Potentiometer
Mechanical data	
Design	Rectangular, Q45
Dimensions	$\varnothing 30 \times 56.4 \times 44.5 \times 102.6$ mm
Housing material	Plastic, Thermoplastic material
Lens	plastic, Acrylic
Electrical connection	Connector, M12 × 1, PVC
Number of cores	4

Functional principle

Convergent mode sensors are equipped with a lens in front of the emitter diode that produces a small and intense focal point at a defined distance from the sensor. Similar to diffuse mode sensors, the light reflected by the target is evaluated. Convergent mode sensors are ideal for detection of small targets or colour marks and edge guiding or positioning control of transparent materials. The targets must always be within the focal depth of the sensors. The focal depth is defined as the area in front of or behind the focal point within which the object can be detected. Based on the intense light concentration in the focal point, convergent mode sensors are capable of detecting targets with a low reflectivity.

Excess gain curve
Excess gain in relation to the distance

Technical data

Ambient temperature	-40...+70 °C
Protection class	IP67
Switching state	LED, Red
Excess gain indication	LED, flashing
Tests/approvals	
MTTF	67 years acc. to SN 29500 (Ed. 99) 40 °C
Approvals	CE, FM, CSA
Approvals	ATEX II 1G ATEX II 2G ATEX II 3G
Device marking	⊕ II 1 G Ex ia IIC T5 Ga
Ignition protection category	Ex ia IIC T5
Ex approval acc. to conformity certificate	FM12ATEX0094X

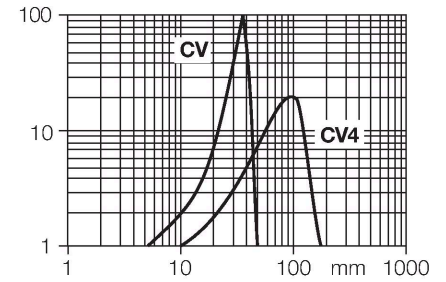

Accessories

SMB30A

3032723

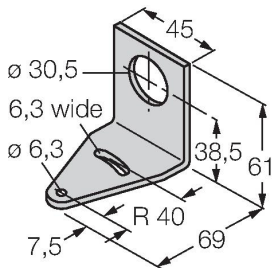

Mounting bracket, rectangular, stainless steel, for sensors with 30mm thread

SMB30FAM10

3011185

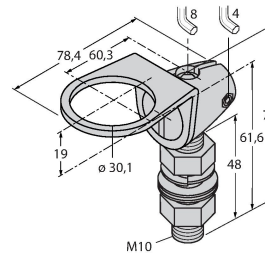

Mounting bracket, stainless steel, for M10 x 1.5 thread, thread length 30 mm

SMB30SC

3052521

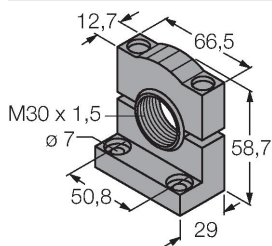

Mounting bracket, PBT black, for sensors with 30 mm thread, rotatable

Accessories

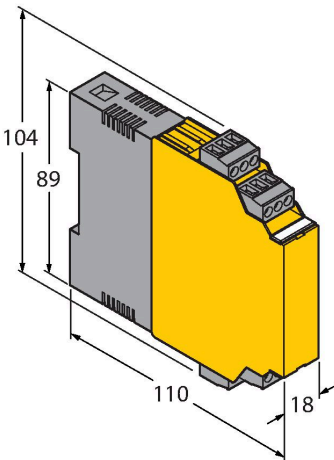
Dimension drawing	Type	ID	
	IM1-22EX-R	7541231	Isolating switching amplifier, 2-channel; 2 relay outputs; input NAMUR signal; selectable ON/OFF mode for wire-break and short-circuit monitoring; adjustable output mode (NO / NC mode); removable terminal blocks; width 18 mm; universal power supply unit

Operating Instructions

Intended use	This device fulfills the directive 94/9/EC and is suited for use in explosion hazardous areas according to EN60079-0:2009, -11:2012, -26:2007. In order to ensure correct operation to the intended purpose it is required to observe the national regulations and directives.
For use in explosion hazardous areas conform to classification	II 1 G (Group II, Category 1 G, electrical equipment for gaseous atmospheres).
Marking (see device or technical data sheet)	⊕ II 1 G and Ex ia IIC T5 Ga acc. to EN60079-0, -11 and -26
Local admissible ambient temperature	-25...+70 °C
Installation/Commissioning	<p>These devices may only be installed, connected and operated by trained and qualified staff. Qualified staff must have knowledge of protection classes, directives and regulations concerning electrical equipment designed for use in explosion hazardous areas. Please verify that the classification and the marking on the device comply with the actual application conditions.</p> <p>This device is only suited for connection to approved Exi circuits according to EN 60079-0 and EN 60079-11. Please observe the maximum admissible electrical values. After connection to other circuits the sensor may no longer be used in Exi installations. When interconnected to (associated) electrical equipment, it is required to perform the "Proof of intrinsic safety" (EN60079-14).</p>
Installation and mounting instructions	<p>Avoid static charging of cables and plastic devices. Please only clean the device with a damp cloth. Do not install the device in a dust flow and avoid build-up of dust deposits on the device. If the devices and the cable could be subject to mechanical damage, they must be protected accordingly. They must also be shielded against strong electro-magnetic fields. The pin configuration and the electrical specifications can be taken from the device marking or the technical data sheet. In order to avoid contamination of the device, please remove possible blanking plugs of the cable glands or connectors only shortly before inserting the cable or opening the cable socket.</p>
Service/Maintenance	Repairs are not possible. The approval expires if the device is repaired or modified by a person other than the manufacturer. The most important data from the approval are listed.