

Opto-Sensor Laser Measuring System LG5A65PUQ

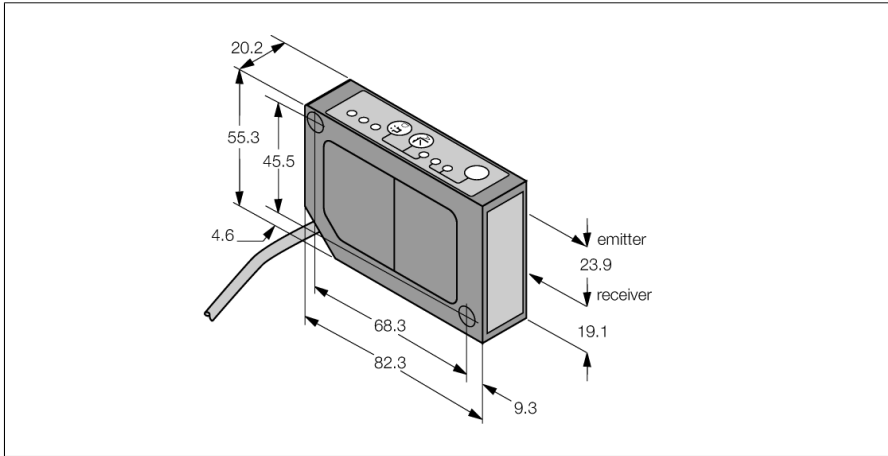

- Cable with male end M12 × 1, 8-pin, 0.15 m
- Measuring range 45...60 mm
- Focal point at 70 mm
- Operating voltage 12...30 VDC
- Analog output 0...10 V
- Indication of signal intensity
- Alarm output
- Slow, medium and fast operation mode adjustable

Wiring Diagram

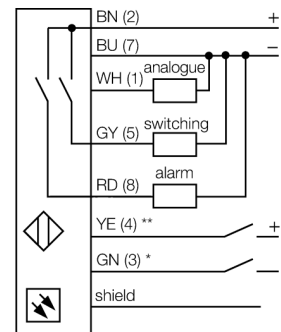

Functional principle

The function principle of the L-GAGE is based on optical triangulation. The emitter and the optics create a light source that is directed towards a target. The target reflects the laser beam back to the receiver lens of the sensor, from where it then falls onto the position sensitive device (PSD) as the receiving element. The target's distance from the receiver determines the angle at which the light meets the receiver element. The integrated microprocessor uses this angle to analyse the target position and to create a corresponding output signal.

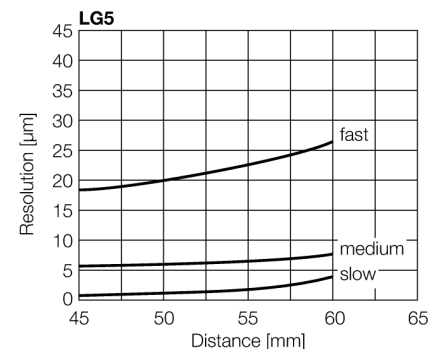

Type designation	LG5A65PUQ
Ident no.	3057566
Function	Proximity switch
Light type	Red
Wavelength	650 nm
Focal distance	70 mm
Laser class	△ 2
Repeatability	0.003 mm
Ambient temperature	-10...+50 °C
Ambient light immunity	5000 lux
Operating voltage	12...30 VDC
Residual ripple	< 10 % U _{ss}
DC rated operational current	≤ 100 mA
No-load current I ₀	≤ 50 mA
Short-circuit protection	yes/ yes
Reverse polarity protection	yes
Output function	NO contact, PNP/Analog output
Voltage output	0...10 V
Load resistance	≥ 2500 Ω
Switching frequency	≤ 500 Hz
Readiness delay	≤ 1.25 s
Readiness delay	≤ 1250 ms
Response time typical	< 1 ms
Approvals	CE, cURus
Design	Rectangular, LG5
Dimensions	82.3 x 20.2 x 55.3 mm
Housing material	Metal, Zinc Alloy Die-Cast, Black-finished
Lens	plastic, Acrylic
Electrical connection	Cable with connector, M12 × 1, PVC
Cable length	0.15 m
Number of cores	8
Core cross-section	0.34 mm ²
Protection class	IP67
Special features	Pushbutton
	Teach input
Power-on indication	LED, Green
Switching state	LED, Yellow

**Opto-Sensor
Laser Measuring System
LG5A65PUQ****Accessories**

Type code	Ident no.		Dimension drawing
SMBLG	3055815	Montagewinkel, Edelstahl 304, für Sensoren der Reihe LG5 und LG10	
SMBLGA	3055906	Montagewinkel, Edelstahl 304, für Sensoren der Reihe LG5 und LG10, mit Verstellerschrauben für präzisere Montage	