



Brüel & Kjær Vibro

A member of the NSK Group

B&K vibro

Product specifications and ordering information

Non-Contacting Displacement Sensor System Series ds821 / Series ds822

4 mm Measuring Range



Copyright © 2023 Brüel & Kjær Vibro GmbH

All rights to this technical documentation remain reserved.

Any corporeal or incorporeal reproduction or dissemination of this technical documentation or making this document available to the public without prior written approval from Brüel & Kjær Vibro GmbH shall be prohibited. This also applies to parts of this technical documentation.

Technical alterations reserved.

Product specifications and ordering information **Sensor ds82x 4 mm**
BPS0135-EN-22, en, date of issue: 05/02/2023

Brüel & Kjær Vibro GmbH

Leydheckerstrasse 10
64293 Darmstadt
Germany

Phone: +49 6151 428 0
Fax: +49 6151 428 1000

Hotline

Phone: +49 6151 428 1400
E-Mail: support@bkvibro.com

Brüel & Kjær Vibro A/S

Lyngby Hovedgade 94, 5 sal
2800 Lyngby
Denmark

Phone: +45 69 89 03 00
Fax: +45 69 89 03 01

Homepage

www.bkvibro.com

BK Vibro America Inc.

1100 Mark Circle
Gardnerville NV 89410
USA

Phone: +1 (775) 552 3110

Corporate E-Mail

info@bkvibro.com

Table of Contents

1	Features	4
1.1	Use	4
1.2	Product description	4
1.3	Colour coding	5
1.4	Scope of delivery.....	6
2	Technical data	7
2.1	Non-Contacting Displacement Sensor System Series ds821 and ds822 ATEX	7
2.2	Displacement sensor type ds82x.ds30xx	8
2.3	Connection cable type ds82x.ec30x (dependent on system design)	9
2.4	Driver ds82x.od13x	9
2.5	Clearances and minimum distances	10
3	Versions and order codes	11
3.1	Diagrams of sensor types (ds).....	11
3.1.1	Design of the displacement sensor type 1 with full-length thread (ds82x.ds3001/...).....	11
3.1.2	Design of the displacement sensor type 2 with full-length thread and corrugated tube (ds82x.ds3002)	12
3.1.3	Displacement sensor type 3 for reverse mounted probe (ds82x.ds3003).....	12
3.1.4	Displacement sensor type 4 for right angled probe (ds82x.ds3004).....	13
3.2	Order code for displacement sensor (ds).....	14
3.3	Diagrams of connection cable (ec).....	16
3.4	Order code for connection cable (ec)	17
3.5	Diagram of driver (od).....	18
3.6	Order code for driver (od).....	19
3.6.1	Mounting adapter for hat-rail or drill-hole mounting	20
3.7	Order code for complete displacement sensor system (mc)	21
4	Approvals	24
4.1	Displacement sensor systems of the series ds822 and series ds821	24
4.2	Additional: Displacement sensor system series ds822 ATEX	24
4.3	Ambient temperature range	25



1 Features

- Non-contacting displacement measurement based on the eddy-current principle
- System length: 5 m, 10 m or 25 m (25 m only ds821)
-  Series ds822 with ATEX approval
- Temperature range displacement sensor: -55 °C ... +180 °C
- Frequency: DC ... 10 kHz
- Compact design of the driver housing (oscillator / demodulator)
- Enhanced tip design
- One driver for both system lengths (system length detected automatically by the driver)
- Reduction of spare parts storage
- Easy assembly due to
 - self-latching push-pull plug connections
 - one mounting adapter for hat-rail or drill-hole mounting
- Excellent precision and temperature stability
- When ordering a complete displacement sensor system, the delivery comes with an acceptance test certificate, including measurement report (factory calibration)

1.1 Use



Relative shaft vibration



Eccentricity



Axial shaft position



Speed



Radial shaft position



Reciprocating Piston drop

1.2 Product description

The displacement sensor systems of the ds820 family are based on the non-contacting eddy-current measurement process. The distance is measured between the tip of the displacement sensor and an electrically conductive surface and sent via a proportional voltage signal to a subsequent monitoring system. In the application range of machine monitoring, this makes it possible to record the status of rotating shafts.

The ECDS system (**E**ddy **C**urrent **D**isplacement **S**ensor) consists of the components of displacement sensor with an integrated cable, an optional separate extension cable and the driver (oscillator/demodulator).

The displacement sensor is available as a forward as well as a reverse-side mountable version.

The ECDS system (**E**ddy **C**urrent **D**isplacement **S**ensor) is available as series ds821 Standard and ds822 ATEX. Each series is available in system lengths of 5 m and 10 m (ds821 also available in 25 m length).

The name of a component is a combination of the series name (ds821 or ds822 ATEX) and the component designation (**mc** = complete system, **ds** = displacement sensor, **ec** = connection cable or **od** = driver).

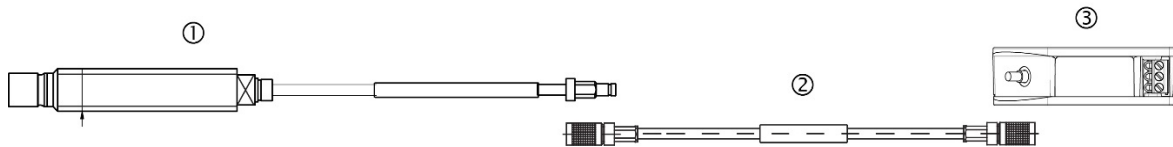

	Displacement sensor system	4 mm Series ds821 Standard:	4 mm Series ds822 ATEX:
	Complete system (mc)	ds821.mc30x	ds822.mc30x
①	Displacement sensor (ds)	ds821.ds30xx	ds822.ds30xx
②	Connection cable (ec)	ds821.ec30x	ds822.ec30x
③	Driver (oscillator/demodulator) (od)	ds821.od13x	ds822.od13x

1.3 Colour coding

The non-contacting displacement sensor systems series ds821 and ds822 are available with various measuring ranges.

Each measuring range is identified by a coloured mark at the end of the integrated cable of the displacement sensor, at the ends of the extension cable and on the driver unit. This makes it easy to identify associated components during installation.

The colour codes according to measuring range are as follows:

Colour code	Blue	Red	Black
Measuring range	2 mm	4 mm	8 mm



1.4 Scope of delivery

Depending on the order, the delivery includes the following components:

Supplied components	Displacement sensor	Connection cable	Driver	Complete sensor system
Displacement sensor	X			X
Protection cap	X			X
2 nuts ¹	X			X
1 O-ring ²	X			X
Connection cable³		X		X
Driver			X	X
Assembly adapter			X	X
Acceptance test certificate acc. to DIN EN 10204	X	X	X	X
Measurement protocol (works calibration)				X
User Manual	X	X	X	X

Table 1-1) Components included in the scope of delivery

¹ not available for ds3003 (reverse mount sensor)

² only available for ds3003 (reverse mount sensor), operating temperature range for o-ring -40 °C to +180 °C, for lower temperatures down to -55 °C o-ring (silicone) on request

³ not available if the length of the displacement sensor with integrated cable corresponds to the nominal system length of 5 m or 10 m.

2 Technical data

These performance characteristics are valid under the following conditions unless specified otherwise:

- +18 °C to +27 °C ambient temperature
- -24 VDC supply voltage
- 100 kΩ load at signal output
- 42CrMo4 B&K Vibro reference material
- -10 V Gap Voltage (approx. 2.5 mm measuring distance between sensor and measuring surface)
- all components are at their operating temperature

2.1 Non-Contacting Displacement Sensor System Series ds821 and ds822 ATEX

Measurand	Displacement
Measuring principle	Eddy-current measuring principle
Nominal system lengths	5 m and 10 m (ds821 also available in 25 m length)
Linear measuring range	4 mm (approx. 0.5 ... 4.5 mm distance from the object to be measured corresponding to an output signal of approx. -2 VDC ... -18 VDC)
Colour code	red
Dynamic characteristics¹	
Sensitivity (ISF) in regard to B&K Vibro Reference material 42CrMo4 (material no. 1.7225) acc. to DIN 17 200, acc. to AISI/SAE 4140.	-4 mV/μm (-101.5 mV/mil)
Accuracy of the sensitivity (ISF error/%) within temperature range of:	
0 °C ... +45 °C (total system) - at a nominal system length of 5 m - at a nominal system length of 10 m - at a nominal system length of 25 m	±5,0 % ±7.5 % ±15 %
-35 °C ... +120 °C (displacement sensor) and -35 °C ... +85 °C (driver od13x) - at a nominal system length of 5 m - at a nominal system length of 10 m - at a nominal system length of 25 m	±10 % ±15 % ±45 %
Deviation from the reference line. (DSL/μm = Deviation from best fit straight line) the temperature range of:	
0 °C ... +45 °C (total system) - at a nominal system length of 5 m - at a nominal system length of 10 m - at a nominal system length of 25 m	±50 μm ± 100 μm ± 200 μm

¹ ISF (Incremental Scale Factor), DSL (Deviation from best fit straight line) and temperature ranges according to API 670



-35 °C ... +120 °C (displacement sensor) and -35 °C ... +85 °C (driver od13x) - at a nominal system length of 5 m - at a nominal system length of 10 m - at a nominal system length of 25 m	±150 µm ±300 µm ±900 µm
Operating frequency range	DC ... 10 kHz (-3 dB damping of the output signal)
Electrical characteristics:	
 Within the temperature range of -35 °C and -55 °C the stated accuracies of dynamical characteristics further decrease.	
Supply voltage (U _B) The sensor system must be connected to a SELV supply be supplied with limited energy, which is fused with a current of ≤ 2.5 A.	-24 VDC (-18 VDC ... -28 VDC)
Output range	0 V ... (U _B + 2 V)
Current consumption	max. 12 mA
Output impedance	50 Ω
Mechanical characteristics:	
Connector type	Coaxial connector (SAA), push-pull self-latching
Cable:	
Cable type	Coaxial
Cable jacket and colour	FEP, blue
Impedance	95 Ω
Diameter	Ø 3.5 mm (± 0.15 mm)
Altitude	< 2000 m

2.2 Displacement sensor type ds82x.ds30xx

Sensor tip:	
Material	Ceramic
Tip diameter	Ø 11 mm (± 0.2 mm)
Sensor housing	
Material	Stainless steel (material no. 1.4404 acc. to DIN 17200)
Maximum tightening torque	5 Nm
Length	
Including integral cable (measured from the sensor's tip to the end of the integral cable)	0.5 m (-0 m / +0.3 m) 1.0 m (-0 m / +0.3 m) 5.0 m (-0 m / +1.0 m) 10.0 m (-0 m / +1.8 m)
Integrated cable	
Minimum bending radius	35 mm without cable protection 35 mm with steel protective conduit 75 mm with PTFE protective conduit ² 100 mm with corrugated tube protection
Connector	Socket (female) or Plug (male) with nominal system length

² The PTFE protective conduit may only be used outside the potentially explosive area or, to prevent static charging, must be fitted with a steel protective conduit or steel tube.

Ambient conditions:	
Degree of protection for the tip acc. to EN 60529	IP 68 / 2 h at 10 bar ³
Pressure tightness (expected as based on the design):	
Sensor tip	25 bar
Sensor and corrugated tube protection	25 bar (valid only for ds3002)
Temperature range:	
Operating temperature range ⁴	-55 °C ... +180 °C
Storage temperature range ⁵	-20 °C ... +70 °C

2.3 Connection cable type ds82x.ec30x (dependent on system design)

Length	4.0 m (-0 m / +0.8 m) 4.5 m (-0 m / +0.8 m) 9.0 m (-0 m / +1.6 m) 9.5 m (-0 m / +1.6 m) 24.0 m (-0 m / +3.4 m)
Minimum bending radius	35 mm without cable protection 35 mm with steel protective conduit 75 mm with PTFE protective conduit ⁶
Connection	Plug (male) at each end
Ambient conditions	
Operating temperature range ⁴	-55 °C ... +180 °C
Storage temperature range ⁵	-20 °C ... +70 °C

2.4 Driver ds82x.od13x

Electric characteristics	
Supply voltage (U_B)	-24 VDC (-18 VDC ... -28 VDC)
Current consumption	max. 12 mA ($R_L \geq 100 \text{ k}\Omega$)
Power supply	max. 1A and short-circuit proof
Source resistance dynamic	50 Ω
Mechanical characteristics	
Housing material	Aluminium alloy (ADC 12)
Dimensions (WxHxD)	26.5 mm x 83 mm x 60 mm
Weight of the driver (Oszillator/Demodulator)	approx. 200 g
Connection	Socket (female)
Ambient conditions	
Degree of protection according to EN 60529	IP 20

³ When stored or operated at a temperature of less than -30 °C, the protection class is reduced to IP65

⁴ When used in hazardous areas, the ambient temperatures of the series ds822 ATEX must be observed, see page 22.

⁵ When stored in original package

⁶ The PTFE protective conduit may only be used outside the potentially explosive area or, to prevent static charging, must be fitted with a steel protective conduit or steel tube.



Temperature	
Operating temperature range ⁴	-55 °C ... +85 °C
Storage temperature range ⁵	-20 °C ... +70 °C
Humidity	98% non-condensing with protection of the plug connections and cable clamp

2.5 Clearances and minimum distances

The clearances and minimum distances specified below must be observed when mounting sensors.

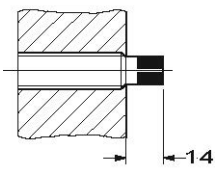
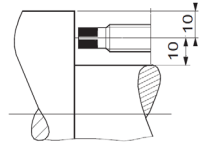
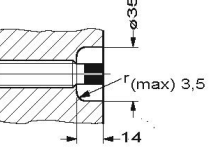
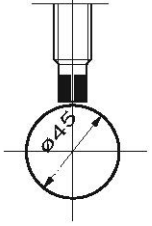
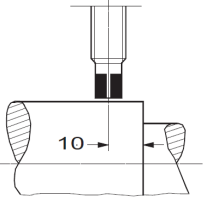
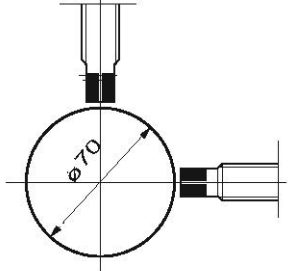
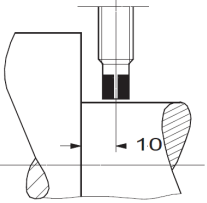
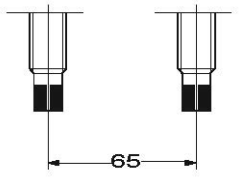
	Sensor tip protruding		Distance to the shaft shoulder, sensor parallel to electrically conductive material
	Sensor tip flush		Required minimum diameter of the shaft for one sensor
	Distance to a shaft end		Required minimum diameter of the shaft with two sensors
	Distance to the shaft shoulder, sensor parallel to electrically conductive material		Parallel arranged sensors

3 Versions and order codes

3.1 Diagrams of sensor types (ds)

3.1.1 Design of the displacement sensor type 1 with full-length thread (ds82x.ds3001/...)

top down:

- Displacement sensor **without cable protection**
 (ds82x.ds3001/TT/LLL/UUU/PPP/000/R)
- Displacement sensor **with steel protective conduit, length XX**
 (ds82x.ds3001/TT/LLL/UUU/PPP/2XX/R)
- Displacement sensor **with PTFE protective conduit, length XX**
 (ds82x.ds3001/TT/LLL/UUU/PPP/3XX/R)

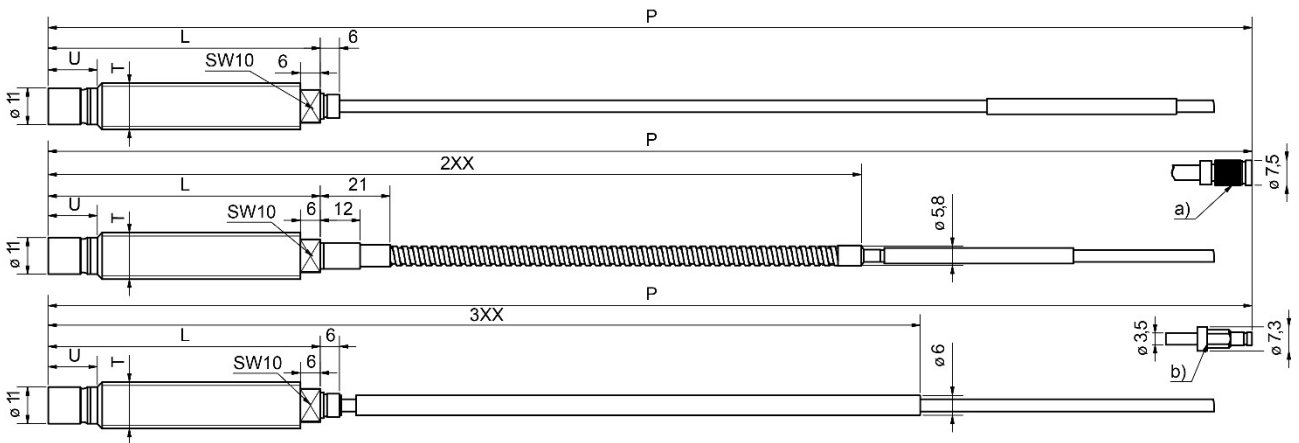

all specifications in [mm]

- a) Plug (male) for straight connect to driver (nominal system length)
 b) Socket (female) for the use of an extra connection cable



3.1.2 Design of the displacement sensor type 2 with full-length thread and corrugated tube (ds82x.ds3002)

top down:

- Displacement sensor **with corrugated tube protection design A**, length **XX**
(ds82x.ds3002/TT/LLL/UUU/PPP/4XX/R)
- Displacement sensor **with corrugated tube protection design B**, length **XX**
(ds82x.ds3002/TT/LLL/UUU/PPP/5XX/R)

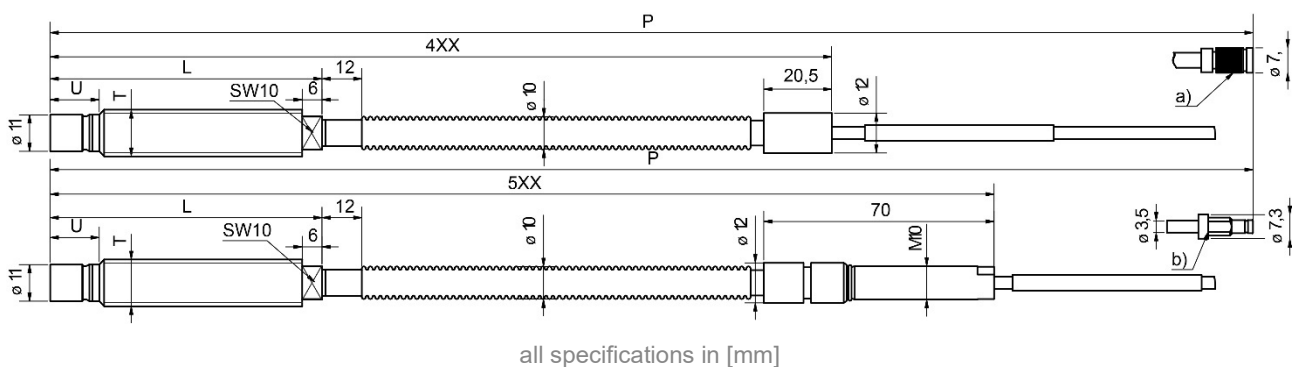

3.1.3 Displacement sensor type 3 for reverse mounted probe (ds82x.ds3003)

- Displacement sensor **for reverse mounting**
(ds82x.ds3003/TT/LL/VV/PP/000 (no protection)/R)

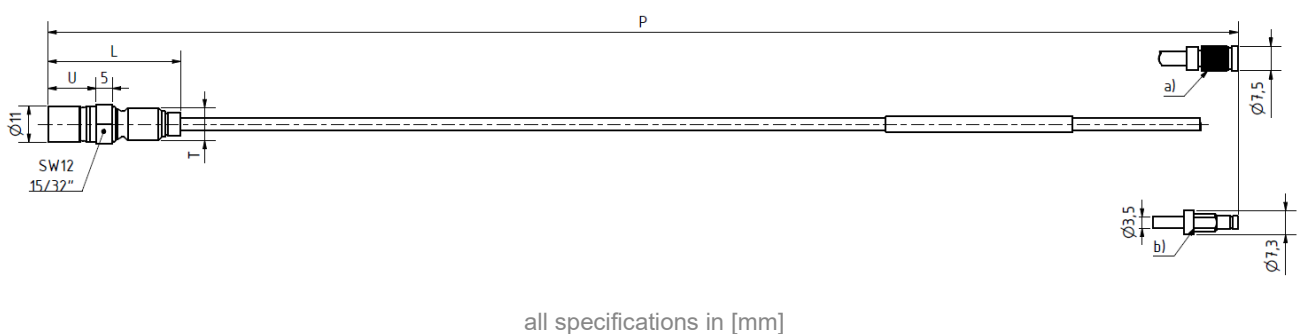

- a) Plug (male) for straight connect to driver (nominal system length)
- b) Socket (female) for the use of an extra connection cable

3.1.4 Displacement sensor type 4 for right angled probe (ds82x.ds3004)

top down:

- Displacement sensor **without cable protection**
 (ds82x.ds3004/TT/LLL/UUU/PPP/000/R)
- Displacement sensor **with steel protective conduit, length XX**
 (ds82x.ds3004/TT/LLL/UUU/PPP/2XX/R)
- Displacement sensor **with PTFE protective conduit, length XX**
 (ds82x.ds3004/TT/LLL/UUU/PPP/3XX/R)

all specifications in [mm]

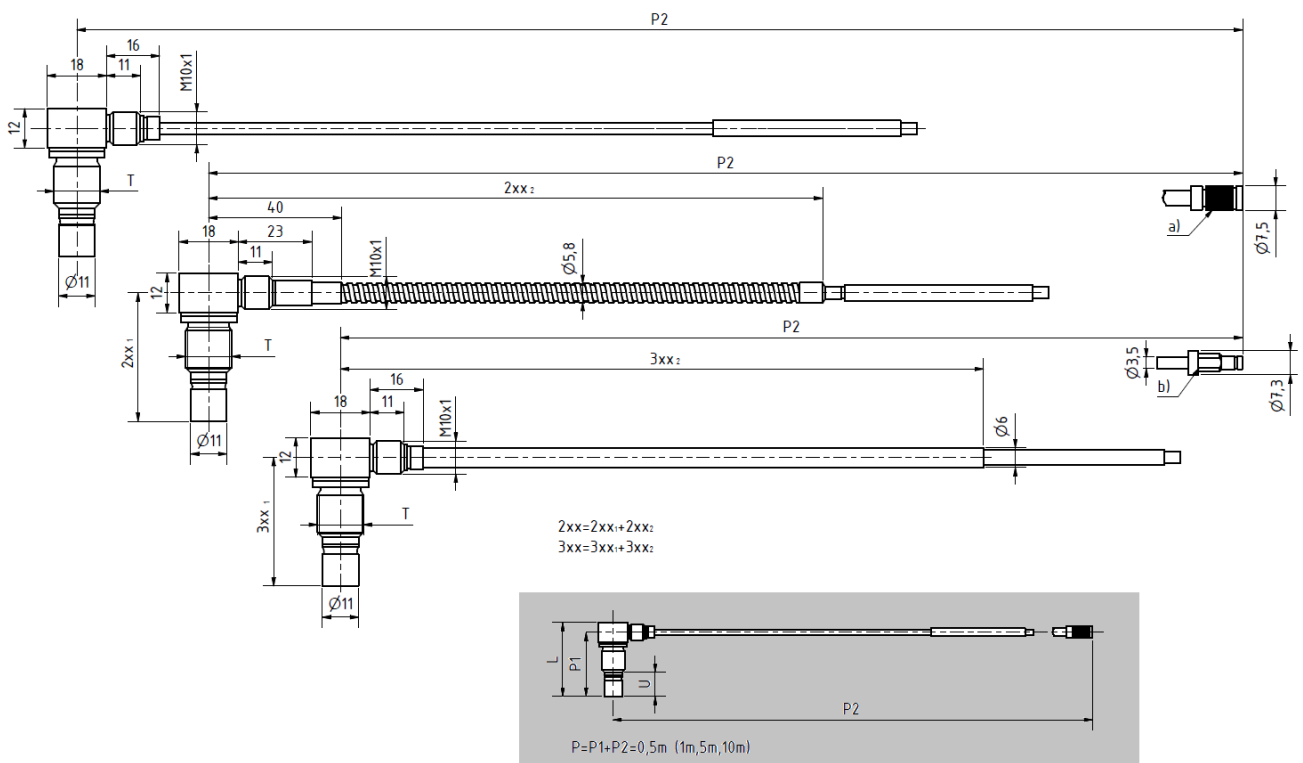

- a) Plug (male) for straight connect to driver (nominal system length)
 b) Socket (female) for the use of an extra connection cable



3.2 Order code for displacement sensor (ds) ds82x.ds300S / TT / LLL / UUU / PPP / CXX / R

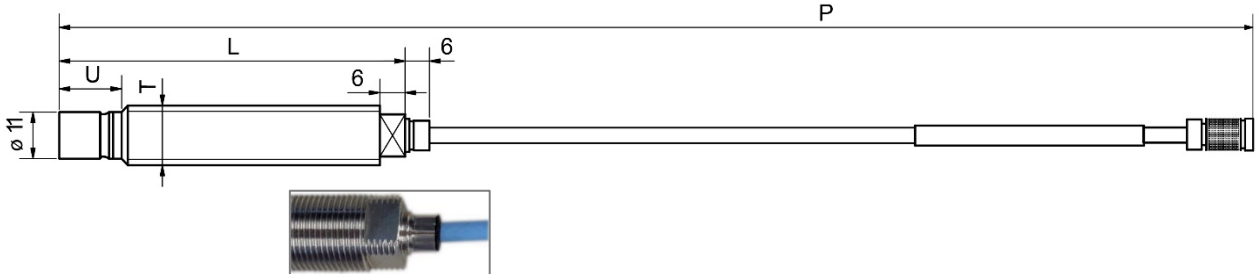

Displacement sensor series	ds821	ds822					x	Order code
Standard	●						1	ds82
ATEX		●					2	

Sensor type	ds3001	ds3002	ds3003	ds3004	/ S	Order code
Full-length thread	●				1	.ds300
Full-length thread with corrugated tube		●			2	
Reverse mounted probe			●		3	
Right - angled head				●	4	

Thread					/ TT	Order code
M10 x 1			●		10	/
M14 x 1	●	●		●	18	
M14 x 1.5	●	●		●	19	
3/8" – 24 UNF-2A			●		62	
1/2" – 20 UNF-2A	●	●		●	70	

Length of the sensor body ¹					/ LLL	Order code
45 mm	●	●	●		045	/
60 mm	●	●		●	060	
85 mm	●	●		●	085	
110 mm	●	●		●	110	
135 mm	●	●		●	135	
Other lengths min ...max [step size 5 mm]	45 ... 285		60 ... 150		XXX	

Unthreaded section ² 005 = 5 mm					/ UUU	Order code
15 mm	●	●	●	●	015	/
Other lengths min ...max [step size 5 mm]	15 ... 245		15 ... 110		XXX	

Length sensor with integrated cable					/ PPP	Order code
0.5 m	●	●	●	●	005	/
1.0 m	●	●	●	●	010	
5.0 m	●	●	●	●	050	
10.0 m	●	●	●	●	100	

¹ Usable thread length = LLL-UUU

² Umax = L - 40 mm, step size 5 mm = '005' measured from the sensor tip to the threadless end

Cable protection (C) and protection length for integrated cable (XX) ³	ds3001	ds3002	ds3003	ds3004	/ CXX
No protection	●		●	●	000
Steel protective conduit	●			●	299 oder 2xx
PTFE protective conduit	●			●	399 oder 3xx
Corrugated tube protective conduit, design A		●			499 oder 4xx
Corrugated tube protective conduit, design B		●			599 oder 5xx

Special requirements - need to be put in writing ⁴					/ R
No	●	●	●	●	0
Yes	upon request				1

For an order, write the number of the selected option in the corresponding boxes on the right. Read from top to bottom, an order code has the following form:

ds82x.ds300S / TT / LLL / UUU / PPP / CXX / R

Order examples ds82x.ds300S:

Series ds821 Standard

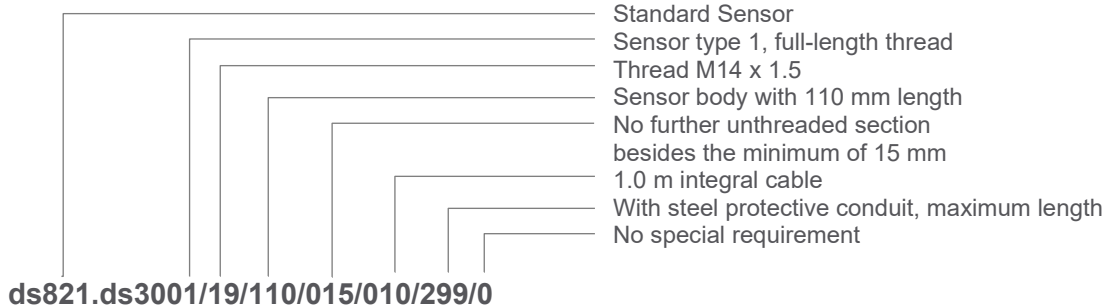

Series ds822 ATEX

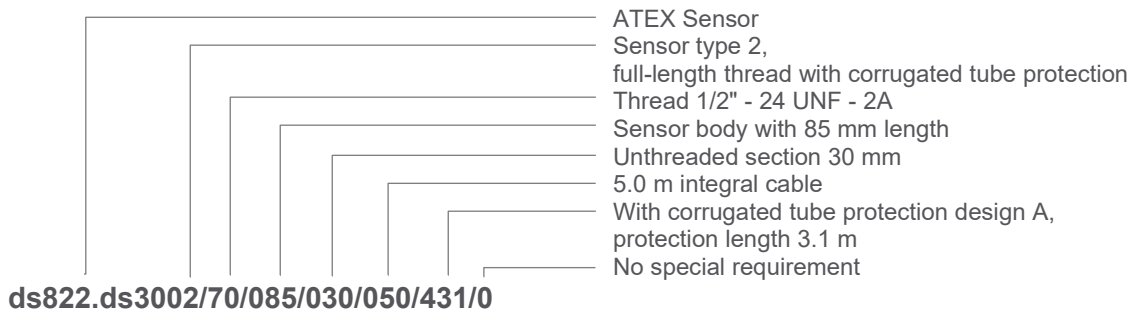

³ The first position C defines the type of the cable protection, CXX = 000 stands for no protection. The second and third positions XX specify the length of the protection. XX = 99 is standard setting and specifies the maximum possible protection length for the selected length sensor with integrated cable. The protection ends about 0.2 m before the end of the plug. The protection length is measured from the sensors tip to the end of the protective conduit. The shortest length is 03 = 0.3 m. The step size is 02 = 0.2 m.

⁴ For a 25 m total system length you need to order the sensor with special requirement Yes (/R=1) with text "sensor for 25 m system length". The only cable protection options available are: "no protection" and "Steel protective conduit"

3.3 Diagrams of connection cable (ec)

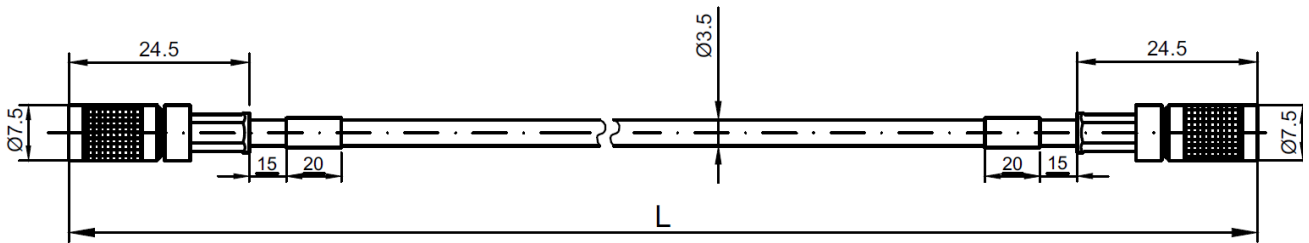

Figure 1) Dimensions of connection cable ds82x.ec300 (no protection)

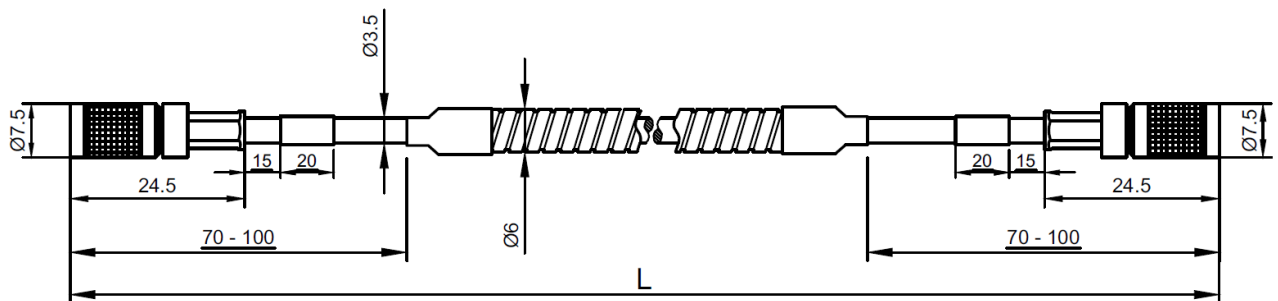

Figure 2) Dimensions of connection cable ds82x.ec302 (steel protection) mechanical reinforcement

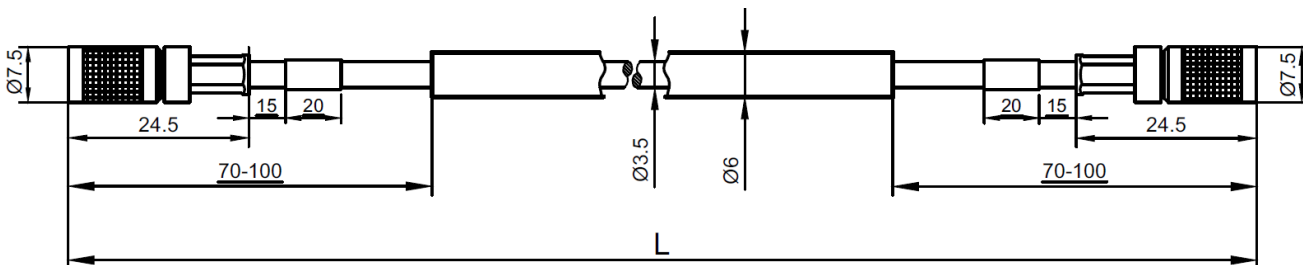
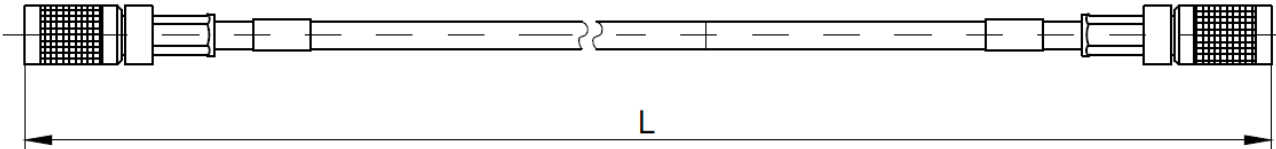

Figure 3) Dimensions of connection cable de82x.ec303 (PTFE tube)

all specifications in [mm]

3.4 Order code for connection cable (ec) ds82x.ec30E / LLL / R



Connection cable for displacement sensor series	ds821	ds822			x	➤	Order code
Standard	●				1		ds82
ATEX		●			2		

Cable protection	ec300	ec302	ec303	/ E	➤	Order code
No protection	●			0		.ec30
Steel protective conduit		●		2		
PTFE protective conduit			●	3		

Length of the connection cable				/ LLL	➤	Order code
4.0 m	●	●	●	040		/
4.5 m	●	●	●	045		
9.0 m	●	●	●	090		
9.5 m	●	●	●	095		
24.0 m	●	●		240		

Special requirements - need to be put in writing				/ R	➤	Order code
No	●	●	●	0		/
Yes	upon request			1		

For an order, write the number of the selected option in the corresponding boxes on the right. Read from top to bottom, an order code has the following form:

ds82x.ec30E / LLL / R

Order examples ds82x.ec30E:

Series ds821 Standard

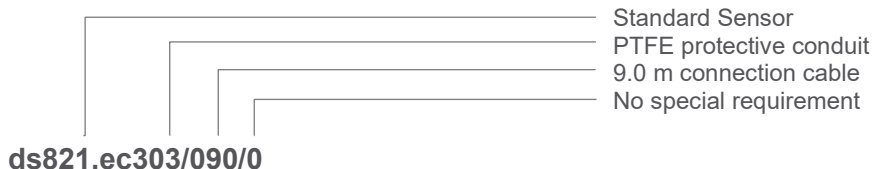



3.5 Diagram of driver (od)

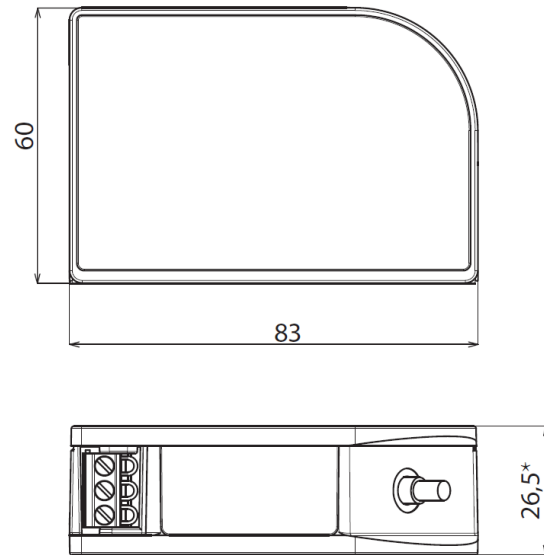

all specifications in [mm]

Figure 4 Dimensions of driver ds82x.od13Y

3.6 Order code for driver (od) ds82x.od13Y / R

Driver for displacement sensor series	ds821	ds822		x	➤	Order code
Standard	●			1		ds82
ATEX		●		2		

Driver for system length	od130	od131	/ Y	➤	.od13
5 m, 10 m	●		0		
25 m		●	1		

Special requirements - need to be put in writing			/ R	➤	/
No	●	●	0		
Yes	upon request		1		



NOTE!

For a 25 m system length please order ds821.od131/0

For an order, write the number of the selected option in the corresponding boxes on the right. Read from top to bottom, an order code has the following form:

ds82x.od13Y / R

Order examples ds82x.od13Y

Series ds821 Standard

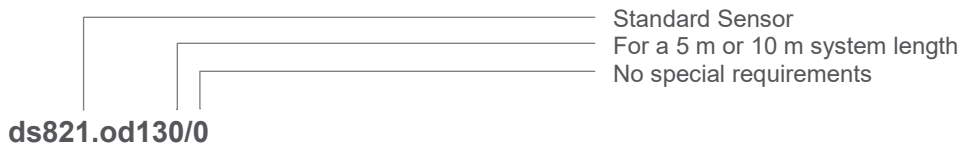

Series ds821 Standard, 25 m cable

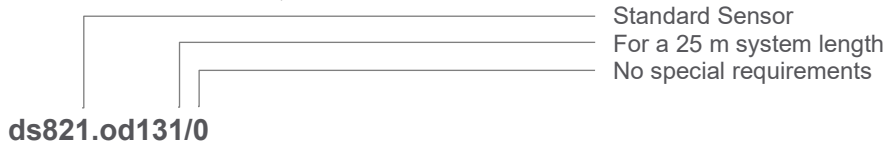



3.6.1 Mounting adapter for hat-rail or drill-hole mounting

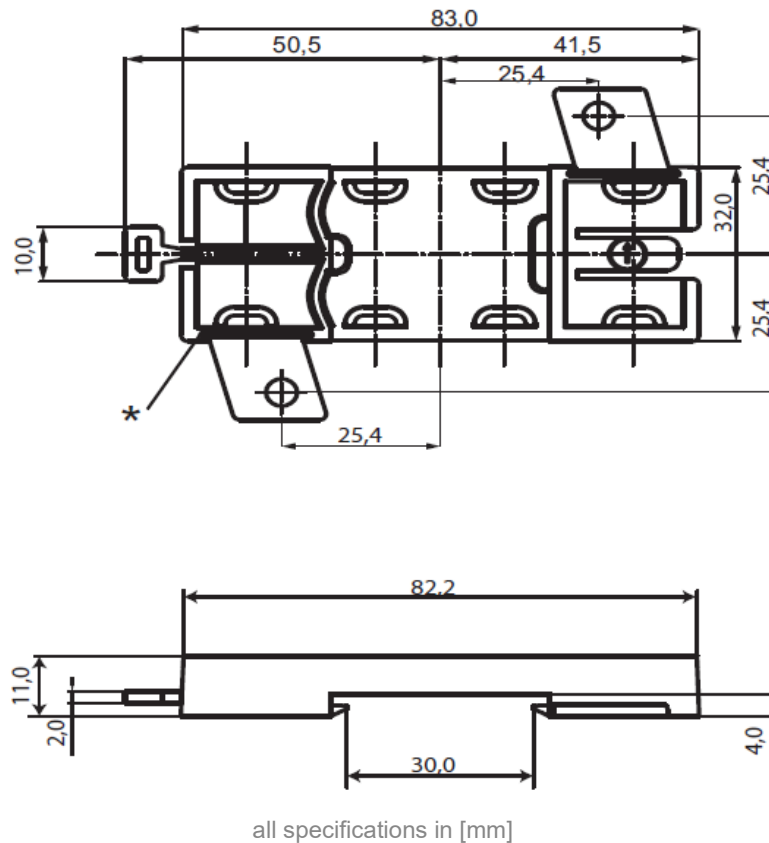
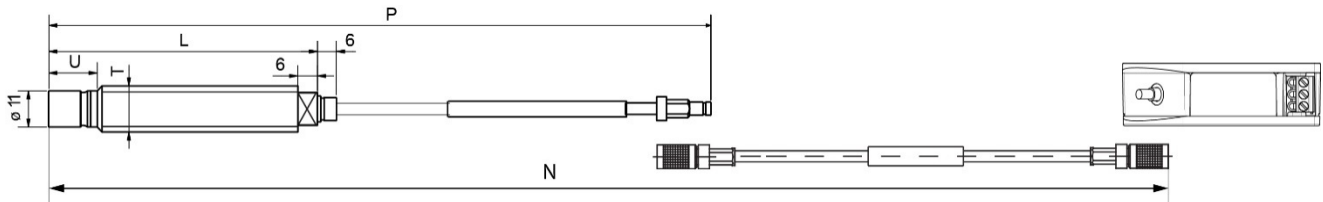

Figure 5) Dimensional diagram of mounting adapter

* Predetermined breaking point for separating the mounting tabs for mounting on hat-rails

The driver (od) can be mounted from both sides on the mounting adapter.

3.7 Order code for complete displacement sensor system (mc) ds82x.mc301 / S / TT / LLL / UUU / NN / PP / CXX / E / R



Displacement sensor series	ds821	ds822					x	Order code
Standard	●						1	ds82 [] .mc301
ATEX		●					2	

Sensor type	ds3001	ds3002	ds3003	ds3004	/ S	
Full-length thread	●				1	/ []
Full-length thread with corrugated tube		●			2	
Reverse mounted probe			●		3	
Right - angled head				●	4	

Thread					/ TT	
M10 x 1			●		10	/ [] []
M14 x 1	●	●		●	18	
M14 x 1.5	●	●		●	19	
3/8" – 24 UNF-2A			●		62	
1/2" – 20 UNF-2A	●	●		●	70	

Length of the sensor body ¹					/ LLL	
45 mm	●	●	●		045	/ [] [] []
60 mm	●	●		●	060	
85 mm	●	●		●	085	
110 mm	●	●		●	110	
135 mm	●	●		●	135	
Other lengths min ... max [step size 5 mm]	45 ... 285			60 ... 150	XXX	

Unthreaded section ² 005 = 5 mm					/ UUU	
15 mm	●	●	●	●	015	/ [] [] []
Other lengths min ... max [step size 5 mm]	15 ... 245			15 ... 110	XXX	

Nominal ECDS system length ³					/ NN	
5 m	●	●	●	●	05	/ [] []
10 m	●	●	●	●	10	
25 m	●		●	●	25	

¹ Usable thread length = LLL-UUU

² Umax = L - 40 mm, step size 5 mm = '005' order code measured from the sensor tip to the threadless end

³ For a 25 m system length: The only cable protection options available are: "no protection" and "Steel protective conduit"



Length of sensor with integrated cable	ds3001	ds3002	ds3003	ds3004	/ PP
Complete nominal system length, no additional connection cable				•	00
0.5 m	•	•	•	•	05
1.0 m	•	•	•	•	10



Cable protection (C) and protection length for the integrated cable (XX) ⁴					/ CXX
No protection	•		•	•	000
Steel protective conduit	•			•	299 oder 2xx
PTFE protective conduit	•			•	399 oder 3xx
Corrugated tube protective conduit, design A		•			499 oder 4xx
Corrugated tube protective conduit, design B		•			599 oder 5xx



Cable protection of connection cable (if available) ⁵					/ E
No protection (ec300)	•	•	•	•	0
Steel protective conduit (ec302)	•	•	•	•	2
PTFE protective conduit (ec303)	•	•	•	•	3



Special requirements - need to be put in writing					/ R
No	•	•	•	•	0
Yes	upon request				1



For an order, write the number of the selected option in the corresponding boxes on the right. Read from top to bottom, an order code has the following form:

ds82x.mc301 / S / TT / LLL / UUU / NN / PP / CXX / E / R

Order examples ds82x.mc301:

Series ds821 Standard

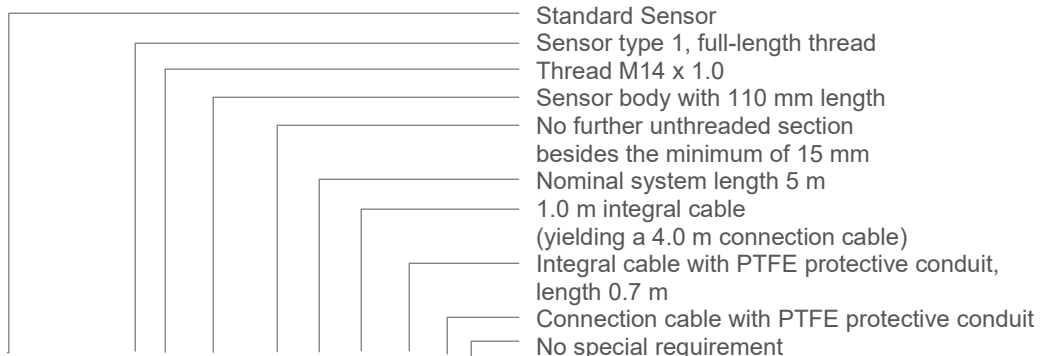

ds821.mc301/1/18/110/015/05/10/307/3/0

⁴ From the sensors tip to the end of the protective conduit. Shortest length: 03 = 3 dm, with step size of 2 dm XX = 00 stands for no protection, XX = 99 is maximum protection length for the selected sensor version (protection ends about 0.2 m before the end of the plug)
⁵ If there is no connection cable (PP = 00), then enter the value "0"

Series ds822 ATEX

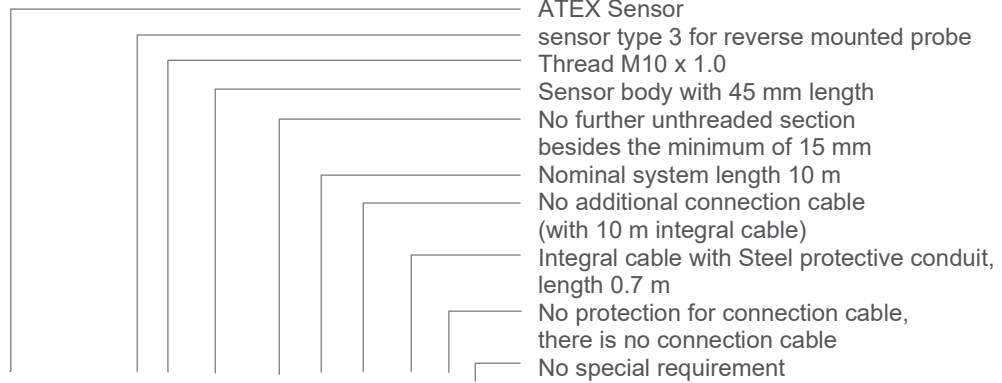

ds822.mc301/3/10/045/015/10/00/307/0/0

Remark:

The length of the possible connection cable is derived automatically from the length of the integral cable and the nominal system length. The delivery contents of a complete measuring system always include a driver of the corresponding series.



4 Approvals

4.1 Displacement sensor systems of the series ds822 and series ds821

- CE compliant acc. to EMC Directive and



- RCM for Australia and New Zealand





4.2 Additional: Displacement sensor system series ds822 ATEX

Use in hazardous Ex-area according 2014/34/EU

EC type examination certificate PTB 12 ATEX 2011 designation



 II 1/2 G Ex ia IIC T6...T1 Ga/Gb or  II 2G Ex ia IIC T6...T1 Gb
 II 2 D Ex ia IIIC T71 °C...168 °C Db

in compliance with EN IEC 60079-0:2018 and EN 60079-11:2012,
EN 60079-26:2015

IECEx- certificate: IECEx PTB 13.0010
 Ex ia IIC T6...T1Ga/Gb or Ex ia IIC T6...T1 Gb
 Ex ia IIIC T71 °C...168 °C Db

Standard: IEC 60079-0:2017
 IEC 60079-11:2012 + Cor. 2012
 IEC 60079-26:2014

Voltage supply: type of ignition protection, intrinsic safety (SELV) Ex ia,
only for protection to a certified, intrinsic safe electric circuit.

Maximum values: $U_i = 28 \text{ V}$ $L_i = \text{negligibly low}$
 $I_i = 140 \text{ mA}$ $C_i = 12 \text{ nF}$
 $P_i = 840 \text{ mW}$ $C_i = 76 \text{ nF (sensor side)}$
 $L_i = 3.8 \text{ mH (sensorside)}$

In Compliance with TR-TS 012/2011 (TP-TC 012/2011)



EAC Ex certificate: RU-C-DE.AX58.B.02032/21
 Ga/Gb Ex ia IIC T6...T1 X or 1Ex ia IIC T6...T1 Gb X
 Ex ia IIIC T 168°C Db

4.3 Ambient temperature range

Temperature class	Permissible ambient temperature range category 1/2 G-equipment		Permissible surface temperature category 2 D-equipment	
	Sensor / Connection cable	Oscillator	Sensor / Connection cable	Oscillator
T6	-55 °C ... +53 °C	-55 °C ... +61 °C	+71 °C	+91 °C
T5	-55 °C ... +65 °C	-55 °C ... +76 °C	+83 °C	+106 °C
T4	-55 °C ... +93 °C	-55 °C ... +79 °C	+111 °C	+109 °C
T3	-55 °C ... +145 °C	-55 °C ... +79 °C	+163 °C	+109 °C
T2, T1	-55 °C ... +150 °C	-55 °C ... +79 °C	+168 °C	+109 °C

Table 4-1) Category 1/2 equipment

Temperature class	Permissible ambient temperature range category 2 G-equipment		Permissible surface temperature category 2 D-equipment	
	Sensor / Connection cable	Oscillator	Sensor / Connection cable	Oscillator
T6	-55 °C ... +67 °C	-55 °C ... +61 °C	+85 °C	+91 °C
T5	-55 °C ... +82 °C	-55 °C ... +76 °C	+100 °C	+106 °C
T4	-55 °C ... +117 °C	-55 °C ... +79 °C	+135 °C	+109 °C
T3, T2, T1	-55 °C ... +150 °C	-55 °C ... +79 °C	+168 °C	+109 °C

Table 4-2) Category 2 equipment

Contact

Brüel & Kjær Vibro GmbH

Leydheckerstrasse 10
64293 Darmstadt
Germany

Phone: +49 6151 428 0
Fax: +49 6151 428 1000

Corporate E-Mail: info@bkvibro.com

Brüel & Kjær Vibro A/S

Lyngby Hovedgade 94, 5 sal
2800 Lyngby
Denmark

Phone: +45 69 89 03 00
Fax: +45 69 89 03 01

Homepage: www.bkvibro.com

BK Vibro America Inc.

1100 Mark Circle
Gardnerville NV 89410
USA

Phone: +1 (775) 552 3110