





Standard cylinder——JSI Series

Product series

Series name	Mounting type								Acting type	Bore size	Collocation of sensor switch													
	Basic	LB	FA	FB	CA	CB	CR	TC			CS1-B	DS1-B	CS1-F	DS1-F	CS1-U	DS1-U								
Double acting type: JSI 	●	●	●	●	●	●	●	●	Double acting	32 40 50 63 80 100 125	●	●	●	●	●	●								
Double rod type: JSID 	●	●	●	●	●	●	●	●			●	●	●	●	●	●								
Adjustable stroke type: JSIJ 	●	●	●	●	●	●	●	●			●	●	●	●	●	●								
Page	208										210								419					



Installation and application

- When load changes in the work, the cylinder with abundant output capacity shall be selected.
- Relative cylinder with high temperature resistance or corrosion resistance shall be chosen under the condition of high temperature or corrosion.
- Necessary protection measure shall be taken in the environment with higher humidity, much dust or water drops, oil dust and welding dregs.
- Dirty substances in the pipe must be eliminated before cylinder is connected with pipeline to prevent the entrance of particles into the cylinder.
- The medium used by cylinder shall be filtered to 40 μm or below.
- Anti-freezing measure shall be adopted under low temperature environment to prevent moisture freezing.
- The cylinder shall be carried out test run without load before application. Prior to run, buffer shall be turned to the minimum and gradually released to avoid the damage on cylinder caused by excessive impact.
- The cylinder shall avoid the influence of side load in operation to maintain the normal work of cylinder and extend the service life.
- If the cylinder is dismantled and stored for a long time, please conduct anti-rust treatment to the surface. Anti-dust caps shall be added in air inlet and outlet ports.

Criteria for selection: Cylinder thrust

Unit: Newton(N)

Bore size (mm)	Rod size (mm)	Acting type	Pressure area (mm ²)	Operating pressure(MPa)								
				0.1	0.2	0.3	0.4	0.5	0.6	0.7	0.8	0.9
32	12	Double acting Push side	804	80.4	160.8	241.2	321.6	402.0	482.4	562.8	643.2	723.6
		Double acting Pull side	690	69.0	138.0	207.0	276.0	345.0	414.0	483.0	552.0	621.0
40	16	Double acting Push side	1256	125.6	251.2	376.8	502.4	628.0	753.6	879.2	1002.4	1130.4
		Double acting Pull side	1055	105.5	211.0	316.5	422.0	527.5	633.0	738.5	844.0	949.5
50	20	Double acting Push side	1963	196.3	392.6	588.9	785.2	981.5	1177.8	1374.1	1570.4	1766.7
		Double acting Pull side	1649	164.9	329.8	494.7	659.6	824.5	989.4	1154.3	1399.2	1484.1
63	20	Double acting Push side	3117	311.7	623.4	935.1	1246.8	1558.5	1870.2	2181.9	2493.6	2805.3
		Double acting Pull side	2803	280.3	560.6	840.9	1121.2	1401.5	1681.8	1962.1	2242.4	2522.7
80	25	Double acting Push side	5026	502.6	1005.2	1507.8	2010.4	2513.0	3015.6	3518.2	4020.8	4523.4
		Double acting Pull side	4536	453.6	907.2	1360.8	1814.4	2268.0	2721.6	3175.2	3628.8	4082.4
100	30	Double acting Push side	7853	785.3	1570.6	2355.9	3141.2	3926.5	4711.8	4288.2	6282.4	7067.7
		Double acting Pull side	7147	714.7	1429.4	2144.1	2858.9	3573.6	4288.3	5003.0	5717.7	6432.4
125	32	Double acting Push side	12272	1227.2	2454.4	3681.6	4908.8	6136.0	7363.2	8590.4	9817.6	11044.8
		Double acting Pull side	11468	1146.8	2293.6	3440.4	4587.2	5734.0	6880.8	8027.6	9174.4	10321.2



Standard cylinder



JSI Series



JSI

Symbol

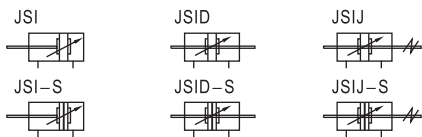

Product feature

1. JIS standard cylinder.
2. The seal of piston adopts heterogeneous two way seal structure. It's dimension is tight and it has the function of greasel reservation.
3. The Mickey Mouse-shaped aluminum barrel of JSI series has no tie rod and good performance of corrosion resistance.
4. Compared with ISO15552 standard cylinder, the cylinder of JSI series with the same cylinder diameter is shorter.
5. The buffer adjustment of cylinder is smooth and steady.
6. Cylinders and mounting accessories for installation with several specifications are optional.
7. The seal material with high temperature resistance is adopted to guarantee the normal operation of cylinder at 150°C.

Specification

Bore size(mm)	32	40	50	63	80	100	125				
Acting type	Double acting										
Fluid	Air(to be filtered by 40 μm filter element)										
Mounting type	JSI, JSIJ	Basic	FA	FB	CA	CB	CR	LB	TC	TCM1	TCM2
Operating pressure	0.1~1.0MPa(15~145psi)(1.0~10.0bar)										
Proof pressure	1.5MPa(215psi)(15bar)										
Temperature °C	-20~80										
Speed range mm/s	30~800										
Stroke tolerance	0~250 ^{+1.0} ₀ 251~1000 ^{+1.4} ₀ 1001~1500 ^{+1.8} ₀										
Cushion type	Variable cushion										
Adjustable cushion stroke mm	24 32 37.5 40										
Port size ①	1/8"		1/4"		3/8"		1/2"				

① PT thread, NPT thread and G thread are available.
Add) Refer to P419~442 for detail of sensor switch.

Stroke

Bore size (mm)	Standard stroke (mm)											Max. std stroke	Max. stroke										
32	25	50	75	80	100	125	150	160	175	200	250	300	350	400	450	500	1000	1800					
40	25	50	75	80	100	125	150	160	175	200	250	300	350	400	450	500	600	700	800	900	1000	1200	1800
50	25	50	75	80	100	125	150	160	175	200	250	300	350	400	450	500	600	700	800	900	1000	1200	1800
63	25	50	75	80	100	125	150	160	175	200	250	300	350	400	450	500	600	700	800	900	1000	1500	1800
80	25	50	75	80	100	125	150	160	175	200	250	300	350	400	450	500	600	700	800	900	1000	1500	1800
100	25	50	75	80	100	125	150	160	175	200	250	300	350	400	450	500	600	700	800	900	1000	1500	1800
125	25	50	75	80	100	125	150	160	175	200	250	300	350	400	450	500	600	700	800	900	1000	1500	1800

Note) Consult us for non-standard stroke.

Ordering code

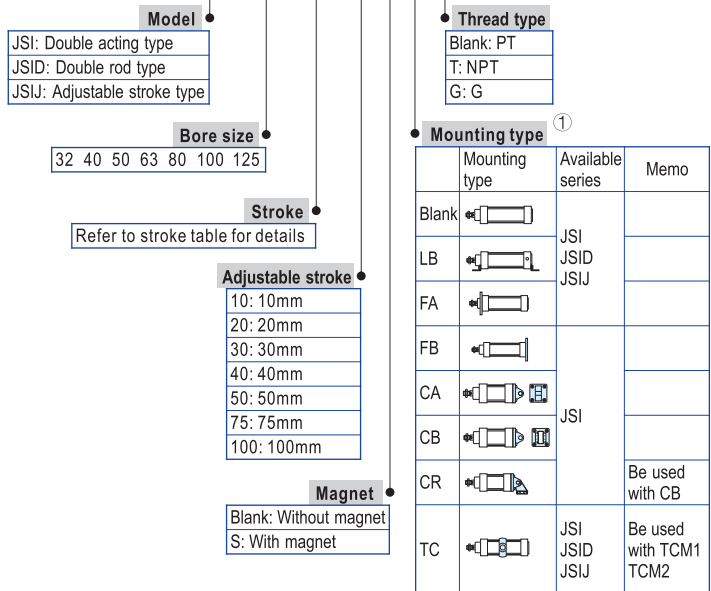
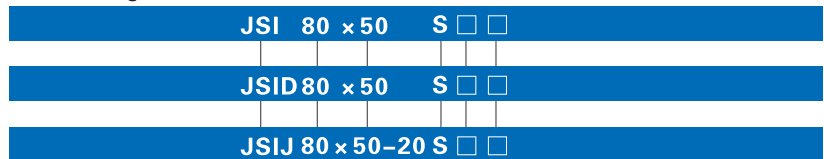

① Please refer to page 210~212 for accessory parts.



Standard cylinder

JSI Series

Inner structure and material of major parts

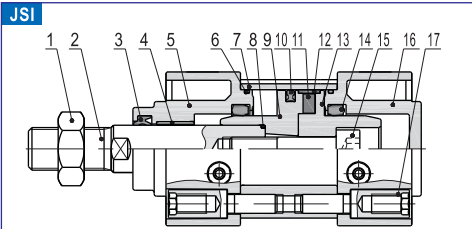

NO.	Item	Material
1	Rod nut	Carbon steel/Stainless steel
2	Piston rod	Carbon steel with 20 μ m chrome plated or Stainless steel
3	Front cover packing	NBR
4	Bushing	Wear resistant material
5	Front cover	Aluminum alloy
6	O-ring	NBR
7	Barrel	Aluminum alloy
8	O-ring	NBR
9	Piston	Aluminum alloy
10	Piston seal	NBR
11	Magnet	Plastic
12	Wear ring	Wear resistant material
13	Magnet holder	Aluminum alloy
14	Buffer gasket	NBR
15	Screw	Carbon steel
16	Back cover	Aluminum alloy
17	Tie-rod nut	Carbon steel

Dimensions

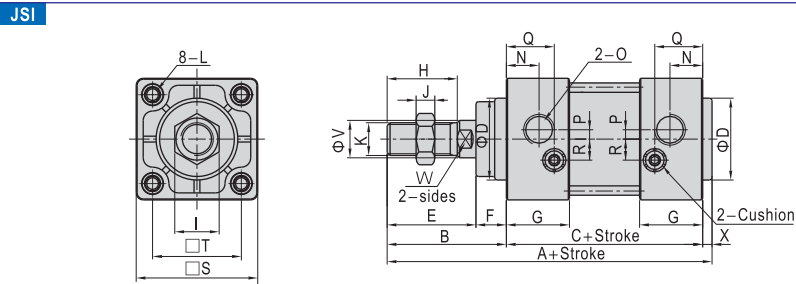

Bore size\Item	A	B	C	D	E	F	G	H	I	J	K
32	135	47	84	30	34	13	27	22	17	6	M10×1.25
40	139	51	84	35	38	13	27	30	19	8	M14×1.5
50	156	58	94	40	44	14	31.5	35	27	11	M18×1.5
63	156	58	94	45	44	14	30.5	35	27	11	M18×1.5
80	190	72	114	45	52	20	38	40	32	13	M22×1.5
100	190	72	114	55	52	20	38	40	36	13	M26×1.5
125	223	97	120	60	70	27	38	54	41	13.5	M27×2

Bore size\Item	L	N	O	P	Q	R	S	T	V	W	X
32	M6	13	1/8"	4	20.5	6.5	46	32.5	12	10	4
40	M6	14	1/4"	4	20.5	9	52	38	16	14	4
50	M8	15.5	1/4"	5	23	10.5	65	46.5	20	18	4
63	M8	16.5	3/8"	9	23	12	75	56.5	20	18	4
80	M10	19	3/8"	11.5	26.5	14	95	72	25	22	4
100	M10	19	1/2"	17	28.5	15	114	89	30	26	4
125	M12	19	1/2"	17	29	15	137	110	32	27	6

Remark: The dimensions of magnet type cylinder are the same as non-magnet type cylinder.

JSID

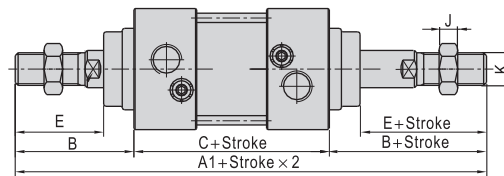

JSIJ

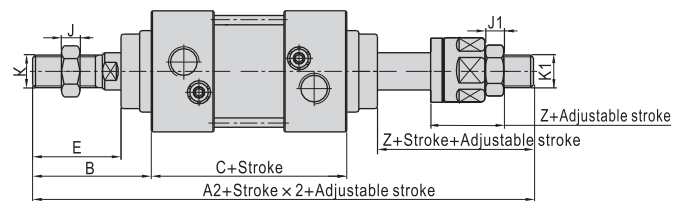

Bore size\Item	A1	A1	B	C	E	J	J1	Z	K	K1
32	178	171	47	84	34	6	6	27	M10X1.25	M10X1.25
40	186	176	51	84	38	8	7	28	M14X1.5	M12X1.25
50	210	195	58	94	44	11	8	29	M18X1.5	M16X1.5
63	210	195	58	94	44	11	8	29	M18X1.5	M16X1.5
80	258	241.5	72	114	52	13	10	35.5	M22X1.5	M20X1.5
100	258	248.5	72	114	52	13	13.5	42.5	M26X1.5	M27X2.0
125	314	286.5	97	120	70	13.5	13.5	42.5	M27X2.0	M27X2.0

Remark:

- The dimensions of magnet type cylinder are the same as non-magnet type cylinder.
- The unmarked dimension is the same as JSI standard type.



JSI

Standard cylinder

Accessories

Ordering code

F-JSI 50 CA

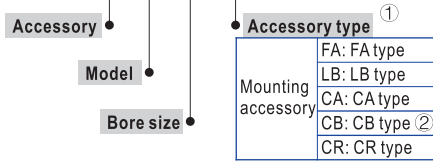

- ① The listed accessories are for JSI cylinder. Accessories that are adaptable to other cylinders are not shown. Please refer to accessory list on P212 for selection and ordering information.
- ② CB is attached with relevant PIN.

Accessory selection

Cylinder model	JSI	JSID	JSIJ	
Accessories	Standard With magnet	Standard With magnet	Standard With magnet	
Mounting accessory	LB	●	●	●
	FA	●	●	●
	FB	●	×	×
	CA	●	×	×
	CB	●	×	×
	CR	●	×	×
	TC	●	●	●
	TCM1	●	●	●
Knuckle	I	●	●	●
	Y	●	●	●
	U	●	●	●
	F	●	●	●
Sensor switch	CS1-B	×	●	×
	DS1-B	×	●	×
	CS1-F	×	●	×
	DS1-F	×	●	×
	CS1-U	×	●	×
	DS1-U	×	●	×

- ① Please refer to P415~418 for knuckle detail.
- ② Please refer to P419~442 for detail of sensor switch.

Material of accessories

Accessories	Mounting accessories								Knuckle				
	LB	FA	FB	CA	CB	CR	TC	TCM1	TCM2	I	Y	F	U
32~63	□	●	●	△	△	◇	◇	□	●	□	□	□	□
80\100	□	●	●	△	△	◇	◇	□	●	□	□	□	□
125	□	■	■	□	□	◇	◇	□	●	□	□	□	□

- — Aluminum alloy, ■ — Cast steel,
- ◇ — Nodular cast iron, △ — FC25; □ — Carbon steel.

Dimensions

LB

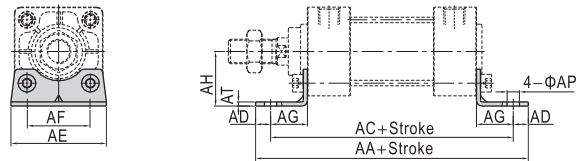

Bore size\Item	AA	AC	AD	AE	AF	AG	AH	AP	AT
32	146	128	9	50	32	22	30	7	3
40	154	132	11	55	38	24	33	9	3
50	170	148	11	70	46	27	40	9	3
63	176	148	14	80	56	27	45	12	4
80	202	174	14	100	72	30	55	12	5
100	210	178	16	120	89	32	65	14	5
125	250	210	20	136	90	45	81	14	8

FA\FB

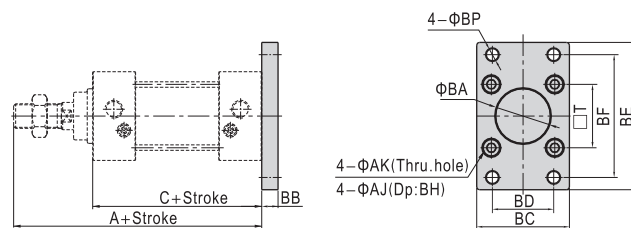
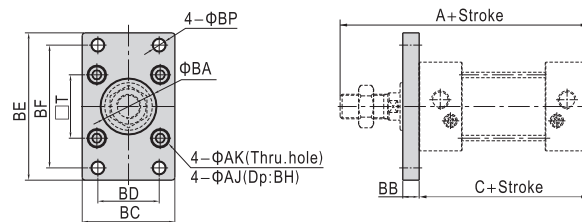

Bore size\Item	A	C	AJ	AK	BA	BB	BC	BD	BE	BF	BH	BP	T
32	131	84	11	6.5	30.5	10	47	32	80	64	6.5	7	32.5
40	135	84	11	6.5	35.5	10	53	36	90	72	6.5	9	38
50	152	94	14	9	40.5	12	65	45	108	90	8.5	9	46.5
63	152	94	14	9	45.5	12	75	50	118	100	8.5	9	56.5
80	186	114	17	11	45.5	16	95	63	150	126	10.5	12.5	72
100	186	114	17	11	55.5	16	115	75	176	150	10.5	14.5	89
125	217	120	19	13	60.5	20	138	102	216	180	12.5	14	110

CA

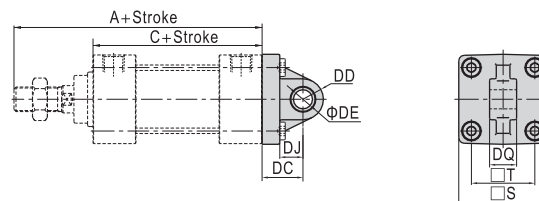

Bore size\Item	A	C	S	T	DC	DD	DE	DJ	DQ
32	131	84	46	32.5	23	10.5	10	13	13.8
40	135	84	52	38	23	11	10	13	13.8
50	152	94	65	46.5	30	15	14	17	19.8
63	152	94	75	56.5	30	15	14	17	19.8
80	186	114	95	72	42	23	22	27	29.8
100	186	114	114	89	42	23	22	27	29.8
125	217	120	136	110	50	28	25	28	31.8



Standard cylinder

Accessories

CB

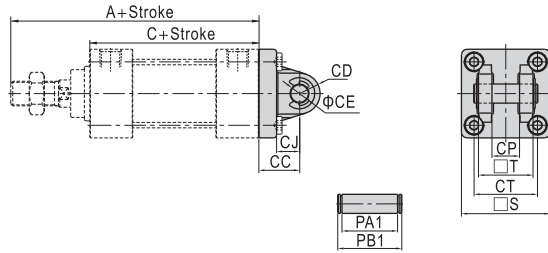

Bore size\Item	A	C	CC	CD	CE	CJ	CP	CT	PA1	PB1	S	T
32	131	84	23	10.5	10	14	14.2	32.5	28.8	34.6	46	28
40	135	84	23	11	10	14	14.2	38	28.8	34.6	52	28
50	152	94	30	15	14	18	20.2	46.5	40.8	47	65	40
63	152	94	30	15	14	18	20.2	56.5	40.8	47	75	40
80	186	114	42	23	22	27	30.2	72	60.8	69.2	95	60
100	186	114	42	23	22	27	30.2	89	60.8	69.2	114	60
125	217	120	50	28	25	32	32.2	110	64.8	73.2	136	64

TC

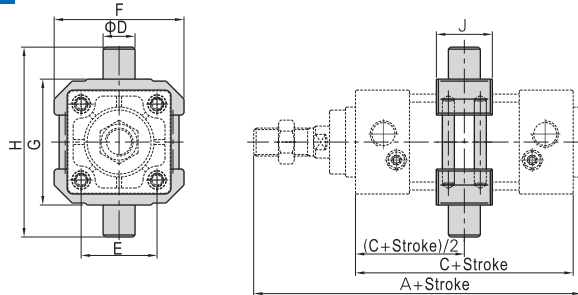

Bore size\Item	A	C	D	E	F	G	H	J
32	135	84	12	32.5	52	50	74	22
40	139	84	16	38	65	63	95	28
50	156	94	16	46.5	75	75	107	28
63	156	94	20	56.5	90	90	130	30
80	190	114	20	72	112	110	150	32
100	190	114	25	89	135	132	182	38
125	223	120	25	110	170	160	210	40

Note) The installation position of the accessories can not be adjusted arbitrarily.

CR

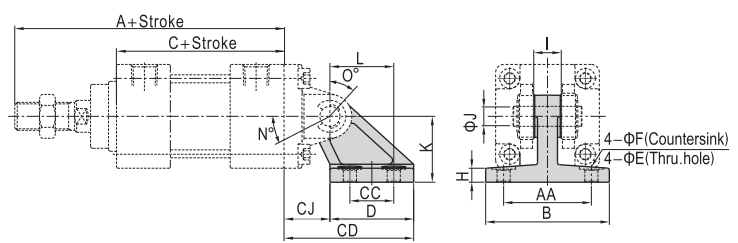

Item	A	AA	B	C	CC	CD	CJ	D	E	F	H	I	J	K	L	N	O	N+O+90°
32	131	44	62	84	22	65	23	42	6.6	12	7	13.8	10	33	32	25	45	160
40	135	44	62	84	22	65	23	42	6.6	12	7	13.8	10	33	32	25	45	160
50	152	60	81	94	30	84.5	31.5	53	9	15	8	19.8	14	45	43	40	60	190
63	152	60	81	94	30	84.5	31.5	53	9	15	8	19.8	14	45	43	40	60	190
80	186	86	111	114	45	120	47	73	11	18	10	29.8	22	65	64	30	55	175
100	186	86	111	114	45	120	47	73	11	18	10	29.8	22	65	64	30	55	175
125	217	110	136	120	60	143	53	90	13.5	20	14	31.8	25	75	78	30	50	170

Note) CR can't be used alone, it must be used with CB.

TCM1

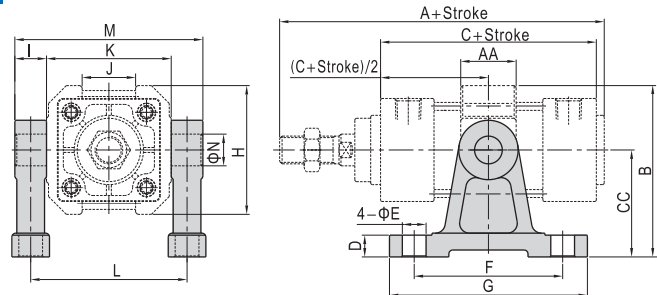

Bore size\Item	A	AA	B	C	CC	D	E	F	G	H	I	J	K	L	M	N
32	135	22	66	84	40	11	9	60	80	52	12	20	50	62	77	12
40	139	28	86.5	84	54	11	12	75	100	65	16	27	63	79	98	16
50	156	28	91.5	94	54	11	12	75	100	75	16	31	75	91	110	16
63	156	30	115	94	70	11	12	85	110	90	20	42	90	110	133	20
80	190	32	126	114	70	11	12	85	110	112	20	54	110	130	153	20
100	190	38	157.5	114	90	19	18	115	155	135	25	68	132	157	185	25
125	223	40	175	120	90	19	18	115	155	170	25	80	160	185	213	25

Note) The installation position of the accessories can not be adjusted arbitrarily.

TCM2

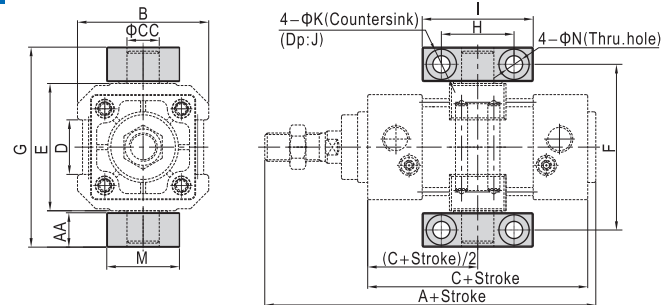

Bore size\Item	A	AA	B	C	CC	D	E	F	G	H	I	J	K	M	N
32	135	14	52	84	12	20	50	66	80	32	46	6.8	11	30	7
40	139	17	65	84	16	27	63	82	99	36	55	9	15	36	9
50	156	17	75	94	16	31	75	94	111	36	55	9	15	36	9
63	156	20.5	90	94	20	42	90	113.5	134	42	65	11	18	40	11
80	190	20.5	112	114	20	54	110	133.5	154	42	65	11	18	40	11
100	190	24.5	135	114	25	68	132	159.5	184	50	75	14	20	50	14
125	223	24.5	170	120	25	80	160	187.5	212	50	75	14	20	50	14

Note) The installation position of the accessories can not be adjusted arbitrarily.



JSI

Standard cylinder

Accessories

List for ordering code of accessories



JSI

Accessories Bore size	Mounting accessory			
	LB	FA	FB	CA
32	F-JSI32LB	F-SI32FA		F-JSI32CA
40	F-JSI40LB	F-SI40FA		F-JSI40CA
50	F-JSI50LB	F-SI50FA		F-JSI50CA
63	F-JSI63LB	F-SI63FA		F-JSI63CA
80	F-JSI80LB	F-SI80FA		F-JSI80CA
100	F-JSI100LB	F-SI100FA		F-JSI100CA
125	F-JSI125LB	F-JSI125FA		F-JSI125CA

Accessories Bore size	Mounting accessory			
	CB	CR	TC	
32	F-JSI32CB	F-JSI32CR	F-SI32TC	
40	F-JSI40CB	F-JSI32CR	F-SI40TC	
50	F-JSI50CB	F-JSI50CR	F-SI50TC	
63	F-JSI63CB	F-JSI50CR	F-SI63TC	
80	F-JSI80CB	F-JSI80CR	F-SI80TC	
100	F-JSI100CB	F-JSI80CR	F-SI100TC	
125	F-JSI125CB	F-JSI125CR	F-SI125TC	

Accessories Bore size	Mounting accessory	
	TCM1	TCM2
32	F-SI32TCM1	F-SI32TCM2
40	F-SI40TCM1	F-SI40TCM2
50	F-SI40TCM1	F-SI40TCM2
63	F-SI63TCM1	F-SI63TCM2
80	F-SI63TCM1	F-SI63TCM2
100	F-SI125TCM1	F-SI125TCM2
125	F-SI125TCM1	F-SI125TCM2

Accessories Bore size	Knuckle			
	I: I Knuckle	Y: Y Knuckle	F: F Knuckle	U: U Knuckle
32	F-M10X125I	F-M10X125Y	F-M10X125F	F-M10X125U
40	F-M14X150I	F-M14X150Y	F-M14X150F	F-M14X150U
50	F-M18X150I	F-M18X150Y	F-M18X150F	F-M18X150U
63	F-M18X150I	F-M18X150Y	F-M18X150F	F-M18X150U
80	F-M22X150I	F-M22X150Y	-	-
100	F-M26X150I	F-M26X150Y	-	-
125	F-M27X200I	F-M27X200Y	-	F-M27X200U

Accessories Bore size	Sensor switch					
	CS1-B	DS1-B	CS1-F	DS1-F	CS1-U	DS1-U
32	CS1-B1	DS1-B1				
40	CS1-B1	DS1-B1				
50	CS1-B2	DS1-B2				
63	CS1-B2	DS1-B2	CS1-F	DS1-F	CS1-U	DS1-U
80	CS1-B3	DS1-B3				
100	CS1-B4	DS1-B4				
125	CS1-B5	DS1-B5				

